

Article number: 51030457000010

Description: Vibration damper GS-M2
100x55x2000-10, NR shore 57

Measures

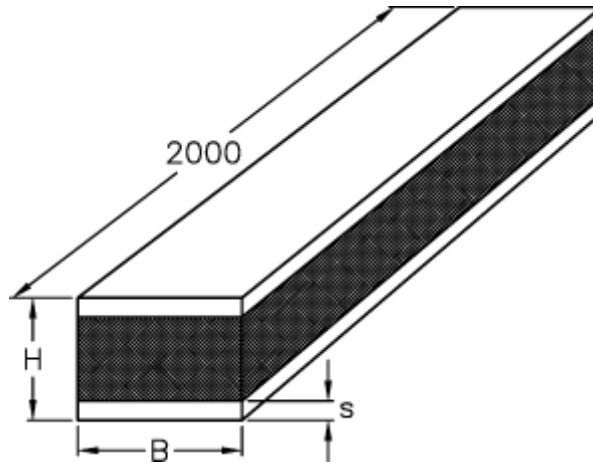

B = 100

H = 55

S = 10